

G4 Multi Channel Weighing Instrument

Program version 1.5.0.0



Operating instructions,
Quick installation
RM type

Contents

Introduction

General	1
Power supply	1
Start-up	2
Maintenance	2
Safety information	2

Service panel

General	3
Display	3
Additional functions	4

Operation

Zero indication and zero adjustment	5
Gross weight and net weight	5
Taring	6
Editing Preset Tare	7
Weight Printing	8
Level supervision	9
Accumulated Weights	10
Flow display (program option)	12
Scale Batching (program option)	13

Installation

Mechanical installation	15
Electrical installation	15
VIEWPAN module	16
CPU unit	17
WF IN, WF IN2 and HS WF2	18

Basic set-up

General	21
Hardware configuration	21
Security lock	21
Common parameters	22
Clock set-up	24
Scale calibration	25
Data sheet calibration	28
Deadweight calibration	31
Zeroing of gross weight	36

Appendix 1

Common set-up values

Appendix 2

Scale set-up values

PRECAUTIONS

READ this manual BEFORE operating or servicing this instrument.

FOLLOW these instructions carefully.

SAVE this manual for future reference.



WARNING

Only permit qualified personnel to install and service this instrument. Exercise care when making checks, tests and adjustments that must be made with power on. Failing to observe these precautions can result in bodily harm.

DO NOT allow untrained personnel to operate, clean, inspect, maintain, service, or tamper with this instrument.

Introduction

General

G4 is a high performance multi channel weighing instrument intended for industrial systems. Its basic function is to convert the signals from strain gauge transducers to useful weight information. Several types of communication interfaces are supported by G4, which makes it easy to integrate the instrument into industrial processes.

G4, type RM, is easily mounted on a DIN rail. All connections and the service panel are accessible from the front end. By a LCD-display and four function keys at the service panel, weight values are presented and parameter values can be viewed and edited.

The basic configuration of the instrument performs weighing and flow rate measurement. All functions are controlled by set-up parameters.

'Operating instructions, Quick installation' for G4 type RM includes basic installation and set-up information, required for correct measuring with the instrument.

This description deals with the following points:

- Weighing with G4 type RM.
- Flow rate measurement (program option).
- Scale Batching (program option)
- Quick installation.
- Data sheet calibration.
- Deadweight calibration in two points.

Additional installation and set-up of more instrument functions, not covered by this description, can also be performed, for example:

- Complete installation.
- Complete set-up.
- Setting of communication parameters.
- Table calibration.
- Level supervision.
- Program option activation.

For a complete instrument description, refer to:

**G4 Multi Channel Weighing Instrument
Technical Manual
RM type**

Power supply

Power supply to the weight indicator should not be turned off during weekends and over-night. Continuous power supply to electronics and transducers prevents moisture condensation in the units.

Start-up

As soon as power is connected to the instrument, it will display 'Vishay' during a start-up period, then the text 'Start up, please wait' is displayed after some seconds. Then G4 automatically switches to normal measuring operation.

If the instrument is set for operator start-up, the text 'Manual start. Push any key!' will be shown until a key is pushed.

If a warm up time has been set, the text 'Warming up Please wait!' will be displayed before the instrument switches to measuring operation.

If any error is detected, the start-up stops and an error message will be displayed.

Maintenance

The G4 instrument needs no maintenance performed by the end-user. Any service or repair work must be performed by qualified personnel. Contact your supplier.

Cleaning

Before cleaning the G4, break the power connection to the instrument. Use a soft cloth to clean the exterior of the instrument.

Safety information

Utilization.

Before connecting power to the instrument, check that all fixation screws at the modules are tightened so that the instruments functional grounding by the housing is maintained.

The instrument may only be utilized for the measurement and control functions, described in the Technical Manual for G4 Multi Channel Weighing Instrument, RM type. It is especially important to adhere to the load limits of the input/output connectors.

We accept no responsibility for any damage arising from improper operation.

Any changes to the instrument, which causes any function changes, may only be carried out by the manufacturer, or after discussion with and permission by the manufacturer.

Meaning of symbols, used in this manual



Direct current.



Caution, risk of danger. Documentation needs to be consulted.

Service panel

General

The service panel VIEWPAN features a two-line, back lighted LCD-display and four function keys. It can display the weight or flow value, or other selected information, for one scale at a time.

It is also possible to connect a standard USB keyboard for PC to the USB connector at the CPU module. The keyboard will work in parallel with the keys on VIEWPAN and will make it easier to handle the configuration of the instrument, as it can be used as an input for digits and characters.

The keyboard keys '+', '-', '↑' or 'Esc', and 'Enter' will correspond the VIEWPAN keys '+', '-', '↑', and '↵'.

Function key 'F11' on the keyboard can be used to access the 'Main Menu'.

Display

During measuring operation the function keys + and – are used to toggle G4 RM between display of measured values for the scales in the instrument.

As G4 RM is in measuring operation the top line shows a weight or flow value. The bottom line, to the left, indicates the actual scale number (S1:, S2: etc.), and information about the measured value (G=gross weight, N=net weight, M=motion, Z=zero, Flow=flow display).

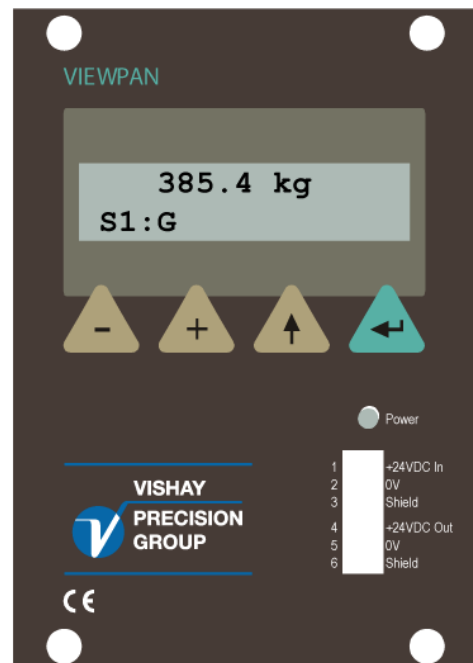

VIEWPAN module

Additional functions

During measuring operation the additional functions for a scale that are activated in the parameter set-up can be displayed to the right on the bottom line.

Key \uparrow toggles the display of additional functions 'on' and 'off'.

As the additional functions are displayed, the keys + and – will perform scrolling of the additional functions that are available for the scale.

Possible functions are: Tare, B/N, Print, Zero, Levels, Pre.Tare, W/F.

See explanations of the functions below.

As key \downarrow is pressed, the displayed additional function will be performed and display of additional functions will be toggled 'off'.

Explanations of the additional functions

Tare: This function performs taring, which means storing of the actual gross weight as auto tare value and switching over to display of net weight. Net weight being the gross weight minus tare.

B/N: This function performs toggling between display of gross weight, indicated by G, and net weight, indicated by N. Net weight cannot be displayed if the tare value in use is zero.

Print: This function initiates a print out of the displayed weight value.

Zero: This function performs Zero adjustment, a zeroing that can be performed only if the gross weight is displayed, stable, and close to the basic zero. Basic zero setting of the gross weight must be performed in the calibration sequences.

Levels: This function gives the possibility to rapidly view and edit the switch-over value for the Levels, assigned to the scale. Function Levels can be used only if at least one of the 32 Levels is assigned for the scale in sub menu Param. Set-up / Level Superv.

Pre.Tare: This function opens menu Preset Tare for the scale, where the value of preset tare can be viewed and edited. Preset Tare can be opened only for scales that have Tare Corr.Mode set to Preset or Auto+Preset in the scale calibration.

W/F: This function performs toggling between display of the weight value and and the calculated flow value. Flow display can be selected only if program option 'Flow rate' is activated and Flow Calc. is set to On in the scale calibration.

Operation

Zero indication and zero adjustment

A basic zero setting of the gross weight for unloaded scale is performed at installation as a part of the calibration. When a 'good zero' is displayed, the letter 'Z' is shown under the measurement value.

Minor correction of the zero value may be needed and can rapidly be performed.

Zero adjustment

If, for unloaded scale, the letter 'Z' is not shown, but the gross weight is close to zero, a rapid zero adjustment can be performed.

The gross weight must be stable (letter 'M' not shown) and the zeroing function must be enabled.

Press key ↑.

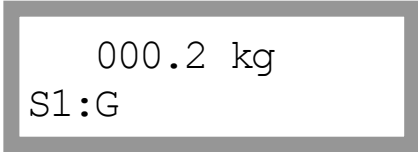

000.2 kg
S1:G

Additional functions for the scale will appear to the right on the bottom line.

Use key + or – to scroll to the Additional function 'Zero'.

Press key ↵ to perform zero adjustment.

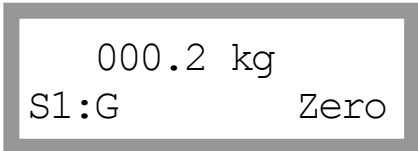

000.2 kg
S1:G Zero

Gross weight, adjusted to zero, is displayed.

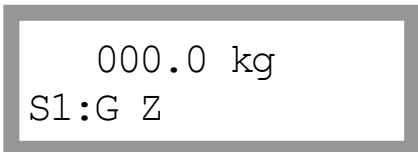

000.0 kg
S1:G Z

Zero adjustment can only be performed if the accumulated deviation from the basic zero setting in the last calibration is within -1 % to +3 % of the 'Capacity'. In other cases a new basic zero setting must be executed.

Gross weight and net weight

The gross weight is the total weight loaded on the scale after zero setting. When gross weight is displayed the letter 'G' is shown under the measurement value.

The net weight is the difference between the gross weight and a tare value. When net weight is displayed the letter 'N' is shown under the measurement value.

Net weight can not be displayed if the tare value is zero.

Switch-over between display of gross weight and net weight can be performed if parameter 'Gross/Net key' is set to 'On'. This makes the additional function 'B/N' available for the scale.

Operating instructions, Quick installation

When gross weight is displayed the letter 'G' is shown under the measurement value.

Press key \uparrow .

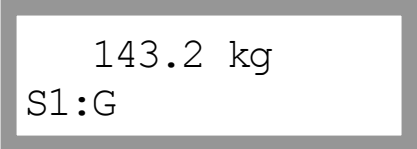

143.2 kg
S1:G

Additional functions for the scale will appear to the right on the bottom line.

Use key + or - to scroll to 'B/N'.

Press key \downarrow to change to display of net weight.

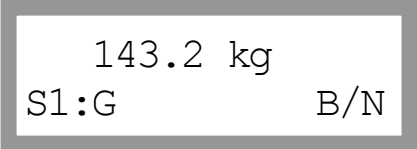

143.2 kg
S1:G B/N

Note: If the tare value is zero, net weight cannot be displayed.

When net weight is displayed, the letter 'N' is shown under the measurement value.

Press key \uparrow .

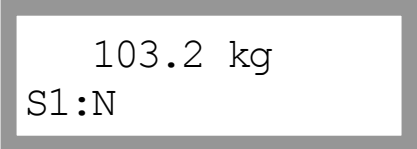

103.2 kg
S1:N

Additional functions for the scale will appear to the right on the bottom line.

Use key + or - to scroll to 'B/N'.

Press key \downarrow to change to display of gross weight.

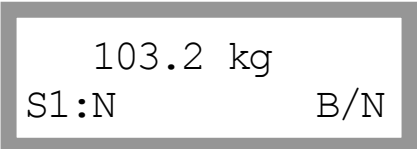

103.2 kg
S1:N B/N

Gross weight is displayed.

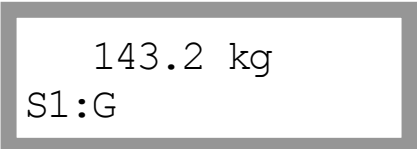

143.2 kg
S1:G

Taring

Taring means storing of a tare value for the scale. Net weight will be calculated as the difference between the gross weight and this tare value. If the tare value is zero, net weight will not be displayed.

At default setting, taring can always be performed if parameter 'Tare key' is set to 'On'. This makes the additional function 'Tare' available for the scale.

But the scale can also be set to allow taring only at stable weight (letter 'M' not shown).

In G4 two tare values can be stored, Auto tare and Preset tare.

Auto tare

By taring, the actual gross weight is stored as Auto tare value, and the scale will switch to display of net weight 'zero'.

Press key \uparrow . Additional functions for the scale will appear to the right on the bottom line.

Use key + or - to scroll to 'Tare'.

Press key \downarrow to perform taring.

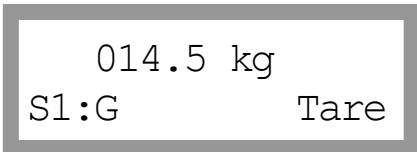

014.5 kg
S1:G Tare

In this example 14.5 kg is stored as an auto tare value.

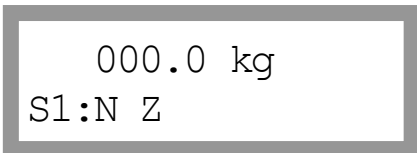

000.0 kg
S1:N Z

Editing Preset tare

In this example Scale 1 is set for taring with 'Preset tare'. The example shows editing the value of 'Preset tare' from VIEWPAN.

Scale 1, set for preset taring,
is in normal weighing operation.

Press key \uparrow to see Additional functions.

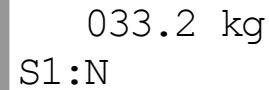

033.2 kg
S1:N

Use key + or - to find the additional
function 'Pre.Tare'.

Press key \downarrow .

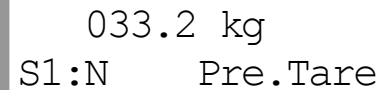

033.2 kg
S1:N Pre.Tare

The value of Preset tare for the scale is shown.

Press key \downarrow to edit the value.

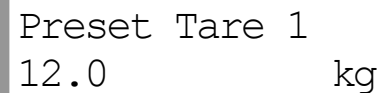

Preset Tare 1
12.0 kg

If the Operator Lock is active, the Operator Code will be needed.

A cursor appears, meaning the value is ready
for editing. Use key + or - to edit one digit
at a time. Accept each digit by pressing key \downarrow .

Finish by pressing key \downarrow for 1 second.

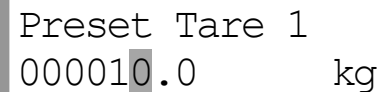

Preset Tare 1
000010.0 kg

The edited value of preset tare
for Scale 1 is displayed.

Press key \uparrow to return to normal weight operation.

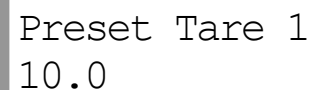

Preset Tare 1
10.0

Scale 1 displays the weight value.

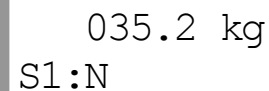

035.2 kg
S1:N

Weight Printing

A printer can be used to print the displayed weight or the displayed flow rate. The printer must be connected to one of the G4 Instrument serial communication ports and the communication parameters must be correctly set.

This example shows how to make a print out of the displayed weight for Scale 1 (the displayed scale) from VIEWPAN.

Scale 1 is selected and in normal weighing operation.
Press key \uparrow to see Additional functions.

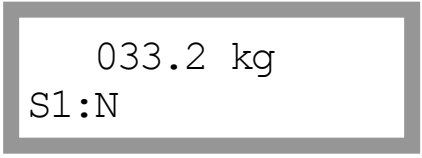

033.2 kg
S1:N

Use key $+$ or $-$ to find the additional function 'Print'.
Press key \downarrow .

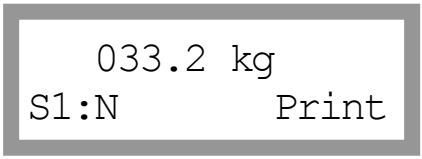

033.2 kg
S1:N Print

The displayed weight value is printed, indicated by a 'P' in the display.

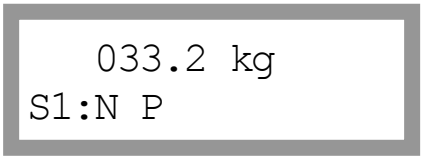

033.2 kg
S1:N P

The print indicator 'P' is shown where the 'Z' (zero) or 'M' (motion) indications normally appear. The print indication will appear even if no printer is configured and indicates that the weight is accumulated.

Print out will be performed provided that:

- The displayed weight is higher than the value of 'Min. Weight Print'. No print out will be done if the weight is too low.
- If 'Motion Check' is turned on, the displayed weight must be stable ('M' not shown).
If the weight is not stable ('M' shown), printing will be delayed and the 'P' will be flashing. When the weight has become stable ('M' not shown) printing will be performed.

Accumulated Weights

Every time a weight is printed the weight value is added to an accumulated value for each scale. Accumulation is done even if no printer is set-up or connected.

Accumulated weights can be changed and set to zero from menu 'Accum. Weights'. This menu is reached from the 'Main Menu'.

Zero setting of accumulated weights for all scales

The example below shows how to set the accumulated weights for all scales in the instrument to zero.

Press the keys + and ↑ simultaneously for 1 second to open 'Main Menu'.

```
123.4 kg
S1:G
```

The 'Main Menu' is displayed.

Use key + or - to find sub menu 'Accum. Weights'.
Press key ↵.

```
Main Menu
Accum. Weights
```

Menu 'Accum. Weights' is displayed with the accumulated weight for the first scale on the lower row.

```
Accum.Weight, S1
3798.100          kg
```

Press the key + a number of times until 'Zero ALL values?' is shown.

Press key ↵ (Yes) to set the accumulated weights for all scales to zero.

```
Zero ALL values?
No                Yes
```

If the Operator Lock is active, the Operator Code will be needed.

A confirm question will be shown.

Press key ↵ (Yes) again to perform the zero setting.

```
Continue?
No                Yes
```

The instrument returns to accumulated weights display.

Press key ↑ several times to return to weight display.

```
Accum.Weight, S1
0.000            kg
```

Edit (zeroing) of accumulated weight for one scale

The example below shows how to edit (zeroing) an accumulated weight for a scale.

Press the keys + and ↑ simultaneously for 1 second to open 'Main Menu'.

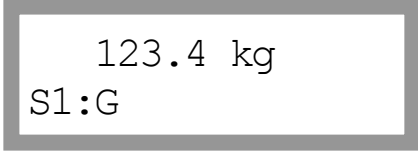

123.4 kg
S1:G

The 'Main Menu' is displayed.

Use key + or – to find sub menu 'Accum. Weights'.
Press key ↵.

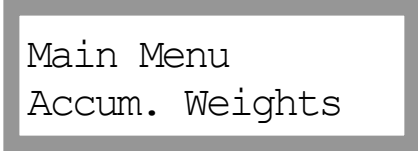

Main Menu
Accum. Weights

Menu 'Accum. Weights' is displayed with the accumulated weight for the first scale on the lower row.

The keys + and – can be used to scroll the list of available scales.

Press key ↵ to edit a displayed value.

If the Operator Lock is active, the Operator Code will be needed.



Accum. Weight, S1
3798.100 kg

A cursor appears, meaning the value is ready for editing.

Use key + or – to edit one cursor position at a time.
Accept the value of each position by pressing key ↵.

Finish by pressing key ↵ for 1 second.

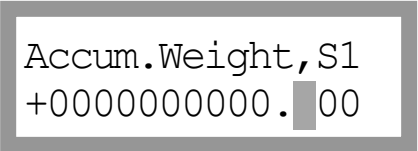

Accum. Weight, S1
+0000000000.00

The new value is displayed.

Press key ↑ several times to return to weight display.



Accum. Weight, S1
0.000 kg

Flow display (program option)

When option Flow display is activated for a scale, the additional function 'W/F' can be shown in the scale display.

When 'W/F' is made visible during weight display, and key \downarrow is pressed, this will switch the scale over to display of flow value.

When 'W/F' is made visible during flow display, and key \downarrow is pressed, this will switch the scale over to weight display.

Example: Scale 1, with the Flow display activated, is in normal operation, displaying an increasing gross weight.

Press key \uparrow to see Additional functions.

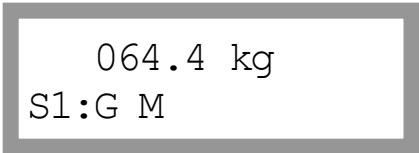

064.4 kg
S1:G M

Use key + or - to find the additional function 'W/F'.

Press key \downarrow .

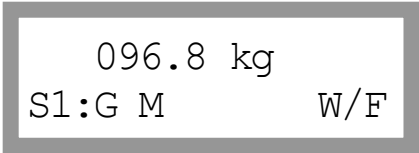

096.8 kg
S1:G M W/F

The measurement value for Scale 1 changes from weight to flow.

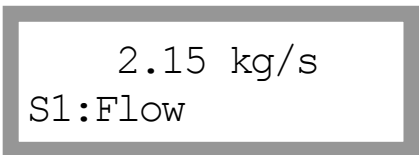

2.15 kg/s
S1:Flow

As the scale is displaying the flow value, press key \uparrow to see Additional functions.

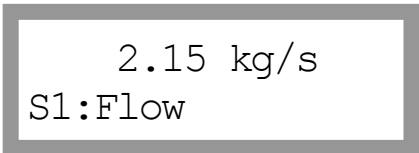

2.15 kg/s
S1:Flow

Use key + or - to find the additional function 'W/F'.

Press key \downarrow .

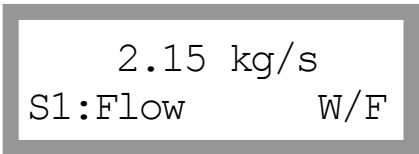

2.15 kg/s
S1:Flow W/F

The measurement value for Scale 1 changes from flow to weight.

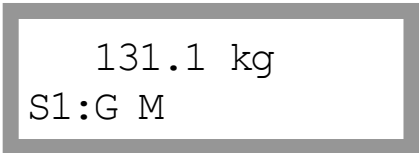

131.1 kg
S1:G M

Scale Batching (program option)

The RM instrument is a complete multi scale batcher but it is not intended as an operator interface for batching. It is possible to set-up the batching sequences from the RM instrument front panel. However for control (start, stop, reset etc) of the batching sequence should a supervising computer be used (PLC, SCADA system etc).

An animated symbol is shown in the weight display, when batching is active (running) for the selected scale.

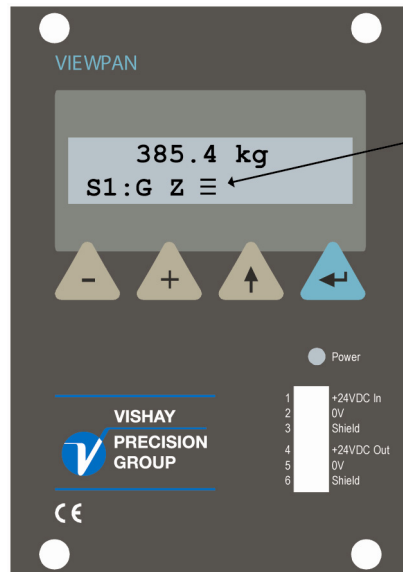

Animated batching indicator symbol

Batched weights

For each scale accumulated weights (batched material) will be created.

In the menu 'Batched Weights', in the 'Main Menu', are the accumulated weights for each configured scale to be found. Each batched weight can be changed, e.g. set to zero (see 'Accumulated Weights' above).

Installation

Mechanical installation

G4 Multi Channel Weighing Instrument type RM is designed for mounting on a flat surface by DIN rail, for example in a protective cabinet. To remove the instrument from the rail, the black lever at the lower bottom side of the instrument must be engaged.

All electrical connections to the instrument are made at the front side so enough room for connectors and appropriate cable ducts should be arranged.

Electrical installation



The field wiring of the instrument shall be suitable to the environment (e.g. chemically) in the end-user application.

Field wiring installation shall comply with any national regulations, hereunder National Electrical Code (NEC) for US and/or Canadian Electrical Code for Canada.

- A switch or circuit-breaker shall be included in the building installation.
- The switch shall be in close proximity to the equipment and within easy reach of the operator
- The switch shall be marked as the disconnecting device for the equipment.
- The equipment switch or circuit-breaker employed as disconnecting device shall comply with relevant requirements of IEC 60947-1 and IEC 60947-3.

The power supply for the instrument should be made via an external DC source.

All electrical connections to the instrument, including connection to ground, are made via plug-in terminal blocks. Shielded cables are needed, except for the power input, and the cables should be routed so that electromagnetic interference from power cables is avoided.

WARNING

Make sure that that the power to the instrument is turned off before:

- *any modules are removed from or inserted in the instrument.*
- *any connections are connected to or disconnected from the instrument.*

All modules should be regarded as ESD sensitive. Make sure that an ESD safe environment is maintained when inserting modules, removing modules and when handling modules separately from the instrument. Modules must be kept in metallised ESD bags when not mounted in the instrument.

VIEWPAN module



The output of the external dc supply must be rated 24 V \pm 15% including fluctuations, min. 40 W. The supply must provide Double Insulation between Mains parts and 24 V SELV or SELV-E circuit; and a limited-energy circuit (max. available current 8 A). For the US market this energy limit can be achieved with an ANSI/UL 248-14 fuse rated 5 A.

For other markets an IEC 60127 T type fuse rated 4 A may also be used.

The power supply unit, designed to supply the complete instrument, is incorporated in the VIEWPAN module.

24 V \pm In

Terminals 1, 2, and 3.

Connect power to terminal 1 (positive) and terminal 2 (0 V). To achieve functional grounding, terminal 3 should be connected to ground.

24 V \pm Out

Terminals 4 (positive) and 5 can be used to supply max. 100 mA to logics, like outputs and inputs.

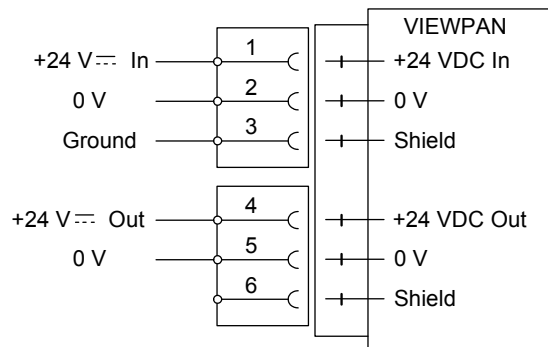

CPU unit

External computing devices connected to the CPU communication interfaces of the instrument have to comply with the standard, UL 60950.

The internal battery in the CPU module is to be used only in the equipment where servicing of the battery circuit and replacement of the lithium battery will be done by a trained technician.



COM1

RS-232 Serial communication.
This is a SELV/SELV-E circuit.

COM1 can be used for serial communication with computer/PLC (Modbus RTU) or a printer.

Point to point communication, only one G4 unit connected to the computer/PLC.

Connections are made to terminals 7 to 9. Shielded cable must be used. Connect the shield to terminal 10.

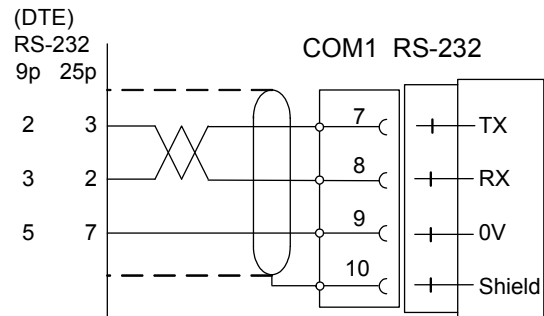

COM2

RS-485 Serial communication for 2-wire or 4-wire with common 0 V.
This is a SELV/SELV-E circuit.

Communication port COM2 can be used for serial communication with computer/PLC (Modbus RTU) or a printer.

Connections are made to terminals 1 to 5. Shielded cable must be used. Connect the shield to terminal 6.

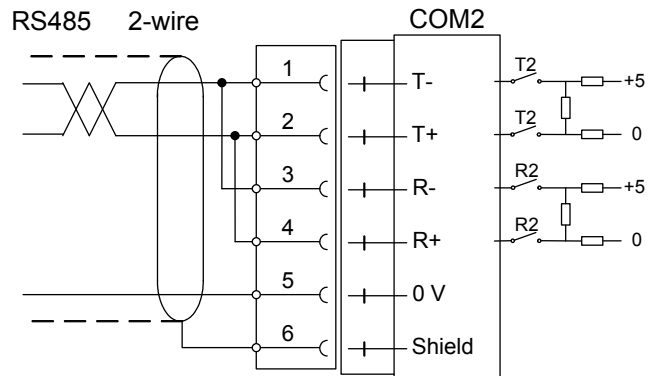

The communication lines must be terminated at both ends.

If G4 is connected at the end of the communication line, the switches T2 and R2 must be set according to the table below.

2-wire termination:
Both T2 switches ON,
both R2 switches OFF.

4-wire termination:
Both T2 switches ON
both R2 switches ON.

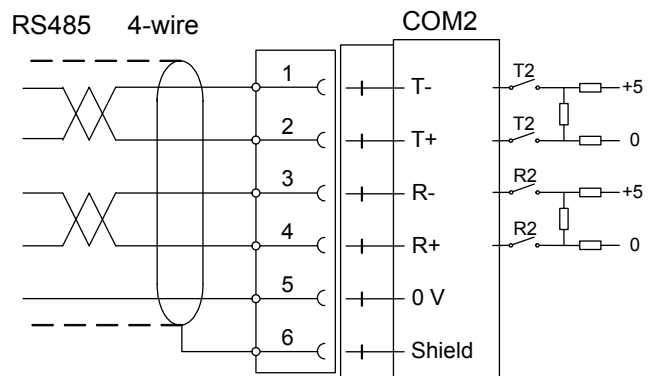

WF IN, WF IN2 and HS WF2



The voltage levels on connectors of I/O modules shall not exceed hazardous voltage levels of 30 Vrms, 42.4 Vpeak or 60 Vdc under normal conditions. In wet locations these voltage levels shall not exceed 16 Vrms, 22.6 Vpeak or 35 Vdc.

Transducer inputs

Terminals 17 – 23 (channel 1), 10 – 16 (channel 2). See next page. Transducer connection should be handled with great care to achieve good measuring data. Transducer integrated cables may not be shortened.

NOTE!

Transducer cables must be routed at least 200 mm away from 230/380 V, 50/60 Hz power cables. By cables with other frequencies or high power, an even wider distance is preferable.

4-wire connection should be used if the transducer integrated cable is long enough to be connected directly to a transducer input. At 4-wire connection, some terminals must be interconnected as shown in the figure on next page.

6-wire connection should be used if the integrated cable must be lengthened or if several transducers should be connected to one transducer input.

The channel 1 cable shield must be connected to terminal 21 and the channel 2 cable shield must be connected to terminal 14.

In WF IN and WF IN2 the shield terminals are internally connected to the G4 housing, which is internally connected to earth via the power supply connector terminal 3 (Shield). The shield shall not be connected at any other point.

In HS WF2 the transducer input channels are separately insulated by operational insulation and the shields can be connected to the most convenient ground/earth point. This can be the junction box when using multiple transducers or at the barrier ground when using Ex zener barriers.

In the junction box SL-4 from Nobel Weighing Systems, see figure, all necessary terminals are provided.

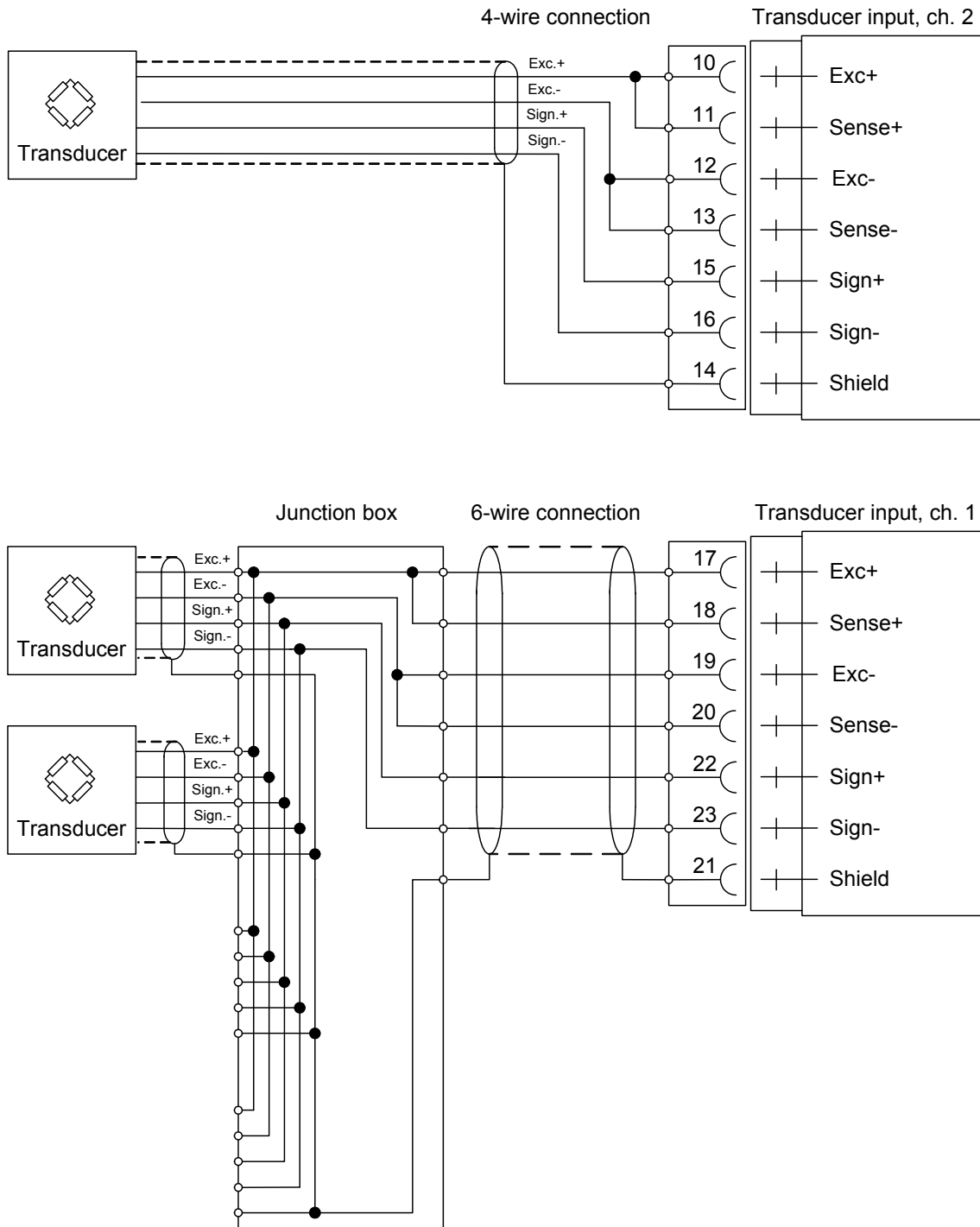

A transducer may be connected directly to terminals at the transducer input.

For several transducers or long distances,
a junction box and lengthening cable is needed.

For a HS WF2 channel, the shield can be connected to
ground/earth at any point.

Basic set-up

General

All operating functions in G4 are controlled by parameters, stored in the instrument memory. The actual setting of the parameter values can be edited during normal weighing operation, by the display and the keys on the service panel VIEWPAN.

WARNING. *Changes done during editing of set-up parameters will affect the behaviour of the instrument immediately. The user must take all necessary precautions to prevent any undesired effects in process monitored or controlled by the G4 instrument or a connected control system.*

It is strongly recommended to activate the set-up lock in the instrument to prevent any unauthorized changes of set-up parameters.

This section proposes a number of parameters to set, that will rapidly give the instrument a useful presentation mode and basic measuring properties. It contains setting of, for example, the measurement unit and resolution for the weight value, and also some parameter settings for data sheet calibration and deadweight calibration in two points.

If you are dealing with an already working instrument we recommend that you perform a backup of the set-up parameters before you make any changes to the instrument.

When the set-up is finished, all parameter values should be noted (see appendix 1 and 2), or backed up in a file. Backup to an USB memory (or internal file) can be done from menu 'Maintenance', sub menu 'Create Backup'.

Appendix 1 and 2 to this manual contains suitable forms to fill in for the instrument hardware configuration and for the set-up parameters, covered by this manual.

Hardware configuration

The instrument G4, type RM, has room for one fieldbus module and three other modules. The configuration of installed modules, used measuring channels, and scale numbers is made in set-up parameter menu 'Hardware Config.'.

At delivery of an instrument, the hardware configuration normally corresponds to the set-up. If any mismatch between installed modules and hardware configuration occurs, an error message will be shown at instrument start-up.

Consult 'G4 Multi Channel Weighing Instrument Technical Manual RM type' if you need to change the hardware configuration.

Security lock

With an instrument G4 it is possible to perform set-up operations during normal operation, which may influence for example the performance of a scale. To prevent these dangers, the instrument is equipped with security locks at two levels that can be activated to protect from unauthorized access to editing of parameters and values. Four-digit codes for the locks can be defined by the customer.

By default setting the code for both locks is: 1 9 3 7 .

Common parameters

G4 has a number of parameters that are common for the whole instrument. They are found in menu 'General', a sub menu to 'Param. Set-up'.

Press the keys + and ↑ simultaneously for 1 second to open 'Main Menu'.

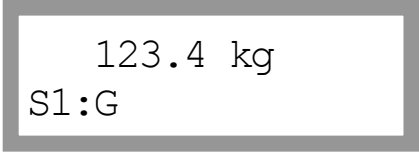

```
123.4 kg
S1:G
```

In 'Main Menu', use key + or – to find sub menu 'Param. Set-up'.

Press key ↵.



```
Main Menu
Param. Set-up
```

In 'Param. Set-up', use key + or – to find sub menu 'General'.

Press key ↵.

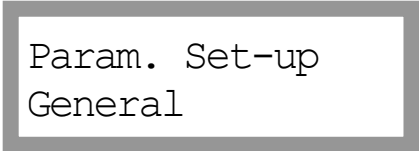

```
Param. Set-up
General
```

Sub menu 'General' is displayed with the first parameter 'Language'. The keys + and – can be used to scroll the list of parameters. Some basic parameters are explained below.

Press key ↵ to perform editing of the displayed parameter.



```
General
Language
```

The Set-up Code or the Operator Code may be needed to start editing.

Language

If parameter 'Language' is selected for editing, the actual language appears on the bottom line with a flashing cursor.

Press key + or – to scroll the alternatives.

The selected language will be used for all text at the display, and for all parameter names.

Press key ↵ for 1 second to accept the displayed alternative.



```
Language
English
```

The selected language is displayed without cursor.



```
Language
English
```

Now key + or – can be used to display another parameter.

Date Format

If parameter 'Date Format' is selected, the actual format appears on the bottom line with a flashing cursor. Press key + or – to scroll the alternatives.

In the alternatives, YYYY stands for 'year', MM stands for 'month', DD stands for 'day'.

Press key ↵ for 1 second to accept the displayed alternative.

The selected date format is displayed without cursor.

Now key + or – can be used to display another parameter.

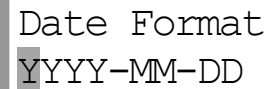

Date Format
Y_YY_Y-MM-DD

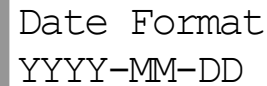

Date Format
Y_YY_Y-M_M-D_D

Time Format

If parameter 'Time Format' is selected for editing, the actual format appears on the bottom line with a flashing cursor.

Press key + or – to scroll the alternatives.

Press key ↵ for 1 second to accept the displayed alternative.

The selected time format is displayed without cursor.

Now key + or – can be used to display another parameter.



Time Format
24 h



Time Format
24 h

Set-up Lock

For security reasons, we recommend setting of this parameter to 'On'.

If parameter 'Set-up Lock' is selected for editing, the actual setting appears on the bottom line with a flashing cursor.

Press key + or – to scroll the alternatives.

Press key ↵ for 1 second to accept the displayed alternative.

The selected alternative is displayed without cursor.

If 'Set-up Lock' is set to 'On', parameter 'Set-up Code' will appear. See below.

Now key + or – can be used to display another parameter.

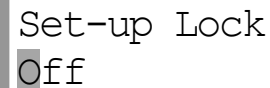

Set-up Lock
Off

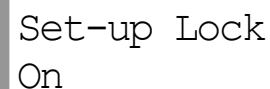

Set-up Lock
On

Set-up Code

If 'Set-up Code' is selected for editing, the actual code appears on the bottom line with a flashing cursor.

Use key + or – to edit the code, digit by digit.

Accept each digit by key ↵.

Press key ↵ for 1 second to accept the displayed code.

The code, replaced by four asterisks, is displayed without cursor.

Now key + or – can be used to display another parameter.

Press key ↑ twice to leave 'General' and return to the 'Main Menu', where a sub menu is available for Clock Set-up of the instrument. See next page.

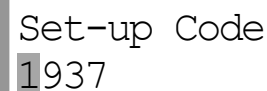

Set-up Code
1937

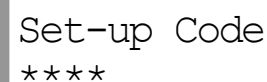

Set-up Code

Clock set-up

Date/time information always exists within G4 RM, but is not presented at VIEWPAN. Setting of correct date and time is performed in 'Clock Set-up', a sub menu to the 'Main Menu'.

Setting of date and time doesn't interrupt normal weighing operation.

(To open the 'Main Menu' from normal weight display, press the keys + and ↑ simultaneously for 1 second.)

In 'Main Menu', use key + or – to find sub menu 'Clock Set-up'.

Press key ↵ to enter the menu.



```
Main Menu
Clock Set-up
```

Parameter 'Date:' is displayed.

To edit the date, press key ↵.



```
Date:
2006-09-23
```

A flashing cursor appears on the bottom line.

Use key + or – to edit the date digit by digit.

Accept each digit by key ↵.



```
Date:
2006-09-24
```

Press key ↵ for 1 second to accept the displayed date. The cursor disappears.

Now key + can be used to display next parameter.



```
Date:
2006-09-24
```

Parameter 'Time:' is displayed.

To edit the time, press key ↵.



```
Time:
19:07:14
```

A flashing cursor appears on the bottom line.

Use key + or – to edit the time digit by digit.

Accept each digit by key ↵.

(Display of time is halted during edit.)



```
Time:
19:09:24
```

Press key ↵ for 1 second to accept the displayed time.

The cursor disappears.

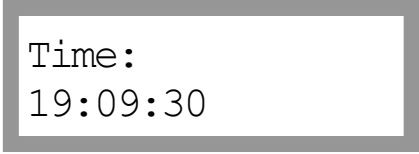

```
Time:
19:09:30
```

Press the key ↑ to leave 'Clock Set-up' and get to the 'Main Menu'.

Scale calibration

All calibration set-up parameters are set individually for each scale. The scale number is used to distinguish parameters for different scales. The following example shows a set-up sequence for Scale 1, so all parameters will begin with 1: .

Individual parameters for the scales are found in menu 'Calibration', a sub menu to 'Param. Set-up'.

('Param. Set-up' is a sub menu to the 'Main Menu'. To open 'Main Menu' from normal weight display, press the keys + and ↑ simultaneously for 1 second.)

In 'Main Menu', use key + or – to find sub menu 'Param. Set-up'.

Press key ↵.



Main Menu
Param.Set-up

In 'Param. Set-up', use key + or – to find sub menu 'Calibration'.

Press key ↵.



Param.Set-up
Calibration

Sub menu 'Calibration' contains settings for the scales that are in use.

Use the keys + and – to find the desired scale number, in this example Scale 1.

Press key ↵.



Calibration
Scale 1

As 'Scale 1' has been selected, the keys + and – can be used to scroll the list of set-up parameters for the scale. Some basic parameters are explained on the following pages.

Press key ↵ to perform editing of the displayed parameter.

The Operator Code or the Set-up Code may be needed to continue.

1:Measurement. Unit

If this parameter is selected for editing, the actual measurement unit appears on the bottom line with a flashing cursor. The measurement unit will be used for the measured value and for related set-up parameters.

Press key + or – to scroll the alternatives.

Press key ↵ for 1 second to accept the displayed alternative.

```
1:Measurement. Unit
kg
```

The selected measurement unit is displayed without cursor.

Now key + or – can be used to display another parameter.

```
1:Measurement. Unit
kg
```

1:Resolution

If this parameter is selected for editing, the actual resolution appears on the bottom line with a flashing cursor. This parameter defines the smallest change in measured value that will be shown, and the decimal point position for the scale.

0.1 means display of 0.0 – 0.1 – 0.2 – 0.3 etc.

0.2 means display of 0.0 – 0.2 – 0.4 – 0.6 etc

0.5 means display of 0.0 – 0.5 – 1.0 etc.

Press key + or – to scroll the alternatives.

```
1:Resolution
0.1
```

Press key ↵ for 1 second to accept the displayed alternative. The selected resolution alternative is displayed without cursor.

```
1:Resolution
0.1
```

Now key + or – can be used to display another parameter.

1:Capacity

If this parameter is selected for editing, the actual capacity with leading zeros appears on the bottom line with a flashing cursor.

This parameter defines the nominal range for the scale. The value of 'Capacity' is shown with measurement unit and decimal point position according to the settings above.

Use key ↵ to position the cursor on a digit to edit.

Then use key + or – to edit the value of the digit, and accept each digit by key ↵.

Press key ↵ for 1 second to accept the edited value for Capacity.

```
1:Capacity
000300.0 kg
```

The edited value of capacity is displayed without cursor.

Now key + or – can be used to display another parameter.

```
1:Capacity
300.0 kg
```

Scrolling the list of parameters for Scale 1 by the key + will bring you to the last display: 'Scale 1 Scale 1 Calib.'

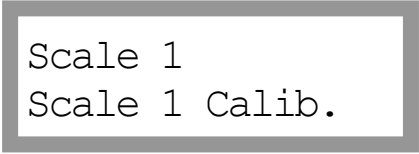

```
Scale 1
Scale 1 Calib.
```

Press key ↵.

1:Calibr. Type

This display shows the current type of calibration for the scale. The keys + and – can be used to scroll the parameter values for this calibration.

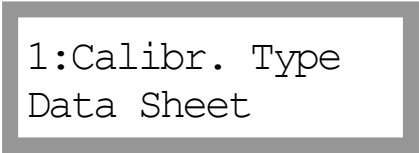

```
1:Calibr. Type
Data Sheet
```

Press key ↵ to start a new calibration.

A cursor indicates that editing of calibration type is possible.

Three calibration types are available:

‘Data Sheet’ calibration for fast calibration when transducer data is available and the installation is free from mechanical disturbances.

‘Deadweight’ calibration, the most accurate calibration type, where known weights are used to give well defined load on the scale.

‘Table’ calibration for entry of recorded values from a previous calibration.

Use the keys + and – to find the type of calibration to perform for the scale.

Press key ↵ for 1 second.



```
1:Calibr. Type
Data Sheet
```

A question will be displayed.

Press key ↵ at 'Yes' to start the calibration.



```
Start calib?
No           Yes
```

Performing a data sheet calibration is described on pages 28 – 31.

Performing a deadweight calibration is described on pages 31– 35.

Data sheet calibration

This calibration method can be used when data sheets for the transducers are available and no external forces influence the weighing installation. If fixed supports are included, the load must be evenly distributed on all supports.

Data sheet calibration can be performed without any transducers connected, but the transducers must be connected as the zero setting is performed.

A data sheet calibration for a scale should start with the scale parameters, described on page 26. This example shows a Data Sheet calibration for Scale 1.

When data sheet calibration has been selected and you have accepted to start a new calibration, the display will show the type of calibration that is selected for the scale.

Use keys + and - to find the parameter that should be edited.



1:Calibr. Type
Data Sheet

Press key ↵ and the parameter value will be displayed with a cursor, ready to edit. All parameters are explained below.

1:Conv. Factor

This parameter defines the relationship between a weight value expressed in transducer data sheet unit and the same weight value expressed in measurement unit. The default value, 9.80665, can be used when transducers in N (Newton) are used for weighing in kg.

If this parameter is selected for editing, the actual conversion factor appears on the bottom line with a flashing cursor.

Use key ↵ to position the cursor on a digit to edit. Then use key + or - to edit the value of the digit, and accept each digit by key ↵.



1:Conv. Factor
009.806650

Press key ↵ for 1 second to accept the edited value for conversion factor.

The conversion factor is displayed without cursor.



1:Conv. Factor
9.80665

Now key + or - can be used to display another parameter.

1:No of Transd

This parameter value should be set to the number of support points for the load, including all transducers and fixed support points. The number will affect the number of parameters '1:Rated Output' below. If this parameter is selected for editing, the number appears on the bottom line with a flashing cursor.

Use the keys + and - to edit the number.

Press key ↵ for 1 second to accept number.

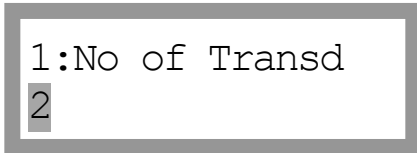

1:No of Transd
2

The number of transducers is displayed without cursor.

Now key + or - can be used to display another parameter.



1:No of Transd
2

1:Rated Load

Rated load for the transducer is a value, given in the data sheet. All the transducers in the scale must have the same impedance and rated load. The rated load value, expressed in the unit of the data sheet, should be entered for this parameter.

If this parameter is selected for editing, the actual rated load appears on the bottom line with a flashing cursor.

Use key \leftarrow to position the cursor on a digit to edit. Then use key + or - to edit the value of the digit, and accept each digit by key \rightarrow .

Press key \rightarrow for 1 second to accept the edited value for rated load.

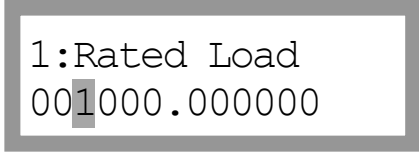

```
1:Rated Load
001000.000000
```

The rated load is displayed without cursor.

Now key + or - can be used to display another parameter.

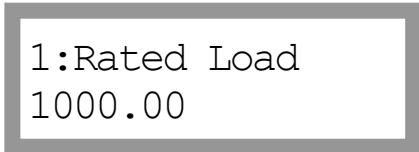

```
1:Rated Load
1000.00
```

1:Rated Output 1, 2, etc.

The number of parameters 'Rated Output' corresponds to 'No of Transd.' above. These parameter values should be set to the output signal values for the transducers, given in the data sheets. For a fixed support point the value of the rated output should be set to 0.00000 mV/V.

If this parameter is selected for editing, the actual rated output appears on the bottom line with a flashing cursor.

Use key \leftarrow to position the cursor on a digit to edit. Then use key + or - to edit the value of the digit, and accept each digit by key \rightarrow .

Press key \rightarrow for 1 second to accept the edited value for rated output.

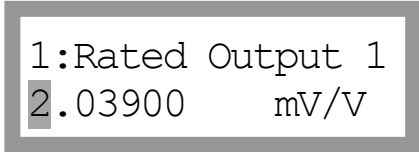

```
1:Rated Output 1
2.03900 mV/V
```

The rated output 1 is displayed without cursor.

Now key + or - can be used to display another parameter.



```
1:Rated Output 1
2.03900 mV/V
```

Enter the Rated Output value for all transducers and fixed support points in the same way.

1:Set Zero

This parameter is used to make the scale display gross weight zero when it is unloaded. Make sure the scale is completely unloaded before this setting is performed.

Press key \downarrow .

```
1:Set Zero
0.00 kg
```

The current gross weight is displayed as a live weight.
Press key \downarrow .

```
Gross Weight:
014.28
```

The value +000000.00 kg is proposed for '1:Set Zero'.
Press key \downarrow for 1 second to accept 0.00 kg.

```
1:Set Zero
+000000.00 kg
```

The zero setting is now finished.
Press key + to display next parameter.

```
1:Set Zero
0.00 kg
```

1:Zero Offset

This parameter shows the offset value, needed to make the scale display the gross weight 'zero' for unloaded scale.

The value of '1:Zero Offset' should not be edited.
Press key + to see actual gross weight.

```
1:Zero Offset
14.28 kg
```

This display of live gross weight gives the possibility to check the load on the scale at any moment during the calibration.

Press key + to see actual transducer signal.

```
Gross Weight:
xxx.xx
```

This display of live transducer signal gives the possibility to check the signal at any moment during the calibration.

```
Transd. Signal:
x.xxxxxx mV/V
```

Exit calibration.

To exit from calibration, press key \uparrow twice.

A question, 'Save calib?', is displayed.

Answer Yes (key \downarrow) to keep the new settings in the instrument memory, or answer No (key $-$) to exit calibration without saving (all changes will be rejected).

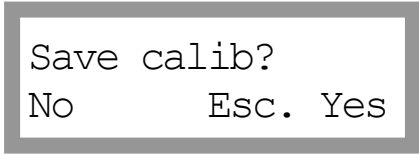

```
Save calib?  
No          Esc. Yes
```

In both cases the instrument switches to sub menu 'Calibration'.

Answer Esc. (key \uparrow) to continue the calibration for Scale 1.

Now it is possible to perform calibration of any remaining scales, or to return to normal weight display by pressing key \uparrow several times.

Deadweight calibration

This is the most accurate calibration method. It requires that known weights to at least two-thirds of the scale capacity are available.

A deadweight calibration should start with the common parameters, described on page 26.

An asterisk ($*$) will be shown at the calibration parameters that have not yet been stored.

This example shows a two-point deadweight calibration for Scale 1.

When deadweight calibration has been selected and you have accepted to start a new calibration, the display will show the type of calibration that is selected for the scale.

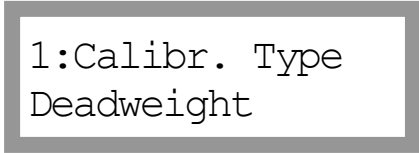

```
1:Calibr. Type  
Deadweight
```

Use keys $+$ and $-$ to find the parameter that should be edited.

Press key \downarrow and the parameter value will be displayed with a cursor, ready to edit.

All parameters are explained on the following pages.

1:No of Cal. P

This parameter defines the number of calibration points. Up to six points can be selected, parameters for load value and transducer signal will be displayed for the selected number of calibration points.

In this example a two-point calibration is described.

If this parameter is selected for editing, the number of calibration points appears on the bottom line with a flashing cursor.

Use keys + and – to edit the number.

Press key ↵ for 1 second to accept the number.

```
1:No of Cal. P
2
```

The number of calibration points is displayed without cursor.

Now key + or – can be used to display another parameter.

```
1:No of Cal. P
2
```

1:Value Cal. P1

This parameter defines the load for the lowest calibration point. Normally the scale should be unloaded and the parameter value set to 0 (zero). This weight value and corresponding transducer signal value are automatically stored for the scale.

Press key ↵.

```
1:Value Cal. P1*
0.0          kg
```

The current gross weight is displayed as a live weight.

Press key ↵.

```
Gross Weight:
014.28
```

The value +000000.0 kg, with a flashing cursor, is proposed.

Press key ↵ for 1 second.

```
1:Value Cal. P1*
+000000.0  kg
```

Parameter '1:Value Cal. P1' is displayed without asterisk.

```
1:Value Cal. P1
0.0          kg
```

1:Value Cal. P2

This parameter, in a two-point calibration, defines the load for the highest calibration point. Normally the scale should be loaded to at least two-thirds of the scale capacity. The weight value and the corresponding transducer signal value are automatically stored for the scale.

Press key \downarrow .

```
1:Value Cal. P2*
500.0          kg
```

The current gross weight is displayed as a live weight.
Press key \downarrow .

```
Gross Weight:
196.52
```

Change the proposed value to the value of the actual calibration load on the scale for calibration point 2.

Use key \leftarrow to move the cursor step by step.
Use key + or - to edit one cursor position at a time.

Accept the value of each position by pressing key \downarrow .

Press key \downarrow for 1 second to accept the load value for point 2.

```
1:Value Cal. P2*
+000200.0    kg
```

Parameter '1:Value Cal. P2' is displayed without asterisk.

```
1:Value Cal. P2
200.0          kg
```

1:T.Signal P1

This parameter value shows the transducer signal for point 1, a value that was automatically stored at the lowest calibration point. The parameter value can not be edited.

```
1:T.Signal P1
0.42971       mV/V
```

1:T.Signal P2

This parameter value shows the transducer signal for point 2, a value that was automatically stored at the highest calibration point. The parameter value can not be edited.

```
1:T.Signal P2
0.67298       mV/V
```

1:Set Zero

This parameter is used to make the scale display gross weight zero when it is unloaded. Make sure the scale is completely unloaded before this setting is performed.

Press key \downarrow .

```
1:Set Zero
0.00 kg
```

The current gross weight is displayed as a live weight.

Press key \downarrow .

```
Gross Weight:
000.12
```

The value +000000.00 kg is proposed for '1:Set Zero'. Press key \downarrow for 1 second to accept 0.00 kg.

```
1:Set Zero
+000000.00 kg
```

The zero setting is now finished.

Press key + to display next parameter.

```
1:Set Zero
0.00 kg
```

1:Zero Offset

This parameter shows the offset value, needed to make the scale display the gross weight 'zero' for unloaded scale. The value of '1:Zero Offset' should not be edited.

Press key + to see actual gross weight.

```
1:Zero Offset
0.12 kg
```

This display of live gross weight gives the possibility to check the load on the scale at any moment during the calibration.

Press key + to see actual transducer signal.

```
Gross Weight:
xxx.xx
```

This display of live transducer signal gives the possibility to check the signal at any moment during the calibration.

```
Transd. Signal:
x.xxxxxx mV/V
```

Exit calibration.

To exit from calibration, press key ↑ twice.

A question, 'Save calib?', is displayed.

Answer Yes (key ↵) to keep the new settings in the instrument memory, or answer No (key –) to exit calibration without saving (all changes will be rejected).

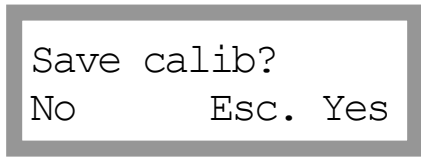

In both cases the instrument switches to sub menu 'Calibration'.

Answer Esc. (key ↑) to continue the calibration for Scale 1.

Now it is possible to perform calibration of any remaining scales, or to return to normal weight display by pressing key ↑ several times.

Zeroing of gross weight

When the scale installation is calibrated, a zeroing is performed in order to make the gross weight zero when the scale is unloaded. If mechanical equipment is added later, this will affect the weight display for the scale, and a new zeroing of the gross weight becomes necessary.

NOTE! The scale must be unloaded when zeroing is performed.

Access 'Set Zero' for any calibration type.

Navigate to sub menu 'Calibration' and select the desired scale, in this example Scale 1.

The sequence is described on page 25.

Press key \downarrow .

```
Calibration
Scale 1
```

Use key $+$ to scroll the parameter list until line 'Scale 1 Scale 1 Calib' is displayed.

Press key \downarrow .

```
Scale 1
Scale 1 Calib
```

Use key $+$ to scroll the parameter list until parameter '1:Set Zero' is displayed.

Press key \downarrow .

```
1:Set Zero
0.00 kg
```

The Set-up Code or the Operator Code may be needed to continue.

Display of live gross weight gives the possibility to check the load on the scale.

Press key \downarrow .

```
Gross Weight:
xxx.xx
```

The value +000000.00 kg is proposed for '1:Set Zero'. Press key \downarrow for 1 second to accept 0.00 kg.

```
1:Set Zero
+000000.00 kg
```

The zero setting is now finished.

```
1:Set Zero
0.00 kg
```

To exit the zero setting, press key \uparrow twice. A question, 'Save calib?', is displayed.

Answer Esc. (key \uparrow) to continue the zero setting of Scale 1.

Answer Yes (key \downarrow) to keep the new zero setting, or answer No (key $-$) to exit calibration without saving (all changes will be rejected).

```
Save calib?
No Esc. Yes
```

In both cases the instrument switches to menu 'Calibration'. Press key \uparrow several times to return to weight display.

Common set-up values

Note: Only the set-up parameters covered in this manual are listed.

Location/Notes:

Software version: Serial number:

Date:

Hardware position	Module	Serial no.	Notes
Slot 1
Slot 2
Slot 3
Slot 4	VIEWPAN
Fieldbus module (at the CPU-unit)

Parameter name	Default value	Set-up value
Language	English
Date Format	YYYY-MM-DD
Time Format	24 h
Set-up Lock	Off
Set-up Code	1 9 3 7

Scale set-up values

Note: Only the set-up parameters covered in this manual are listed.

Locations/Notes:

.....

Module: Ser. no.: Slot no.:

Channel number:

Scale number:

<u>Parameter name:</u>	<u>Default values</u>
X:Measurem. Unit	kg
X:Resolution	0.1
X:Capacity	500.0
X:Calibr. Type	Data sheet
X:Conv. Factor	9.80665
X:No of Transd.	3
X:Rated Load	2000.0
X:Rated Output 1	2.03900
X:Rated Output 2	2.03900
X:Rated Output 3	2.03900
X:Rated Output 4	2.03900
X:No of Cal. P	2
X:Value Cal. P1	0.0
X:Value Cal. P2	500.0
X:T.Signal P1	0.00000
X:T.Signal P2	1.66631
X:Zero Offset	0.00

Document no. 35133
Article no. 600 857 R2c
© Vishay Nobel AB, 2011-06-15
Subject to changes without notice.

Vishay Nobel AB
Box 423, SE-691 27 Karlskoga, Sweden
Phone +46 586 63000 · Fax +46 586 63099
pw.se@vishaypg.com
www.weighingsolutions.com

BLH
3 Edgewater Drive, Norwood, MA 02726, USA
Phone: 781-298-2200 Fax: 781-762-3988
pw.us@vishaypg.com
[www. weighingsolutions.com](http://www.weighingsolutions.com)